



# VARIOspeed<sup>®</sup> 3R User Manual

This VARIOspeed<sup>®</sup> 3R control panel is designed to provide constant pressure control for your pumping system.

Should you need to make minor adjustments, please consult the parameter table enclosed in this document.

Consult the factory for assistance.

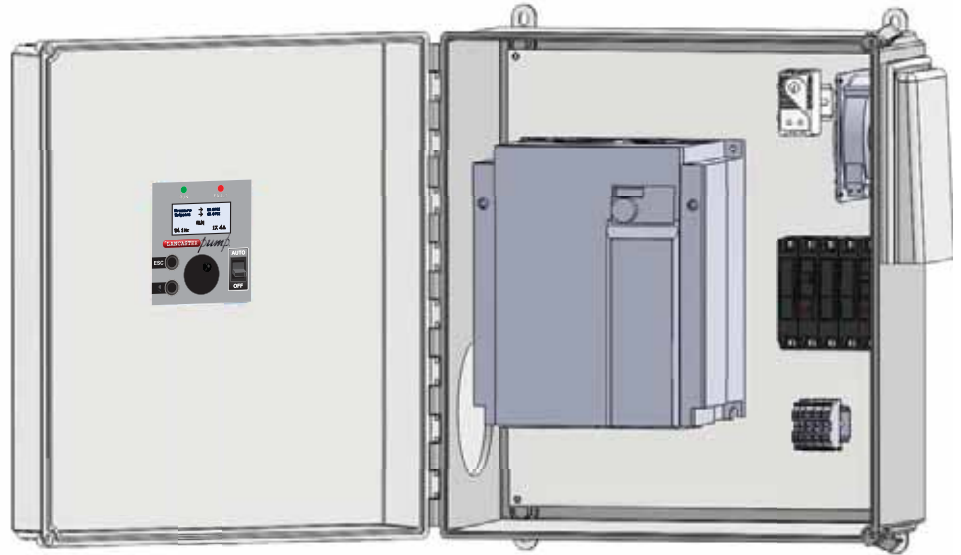

## Pressure Booster Pump Application

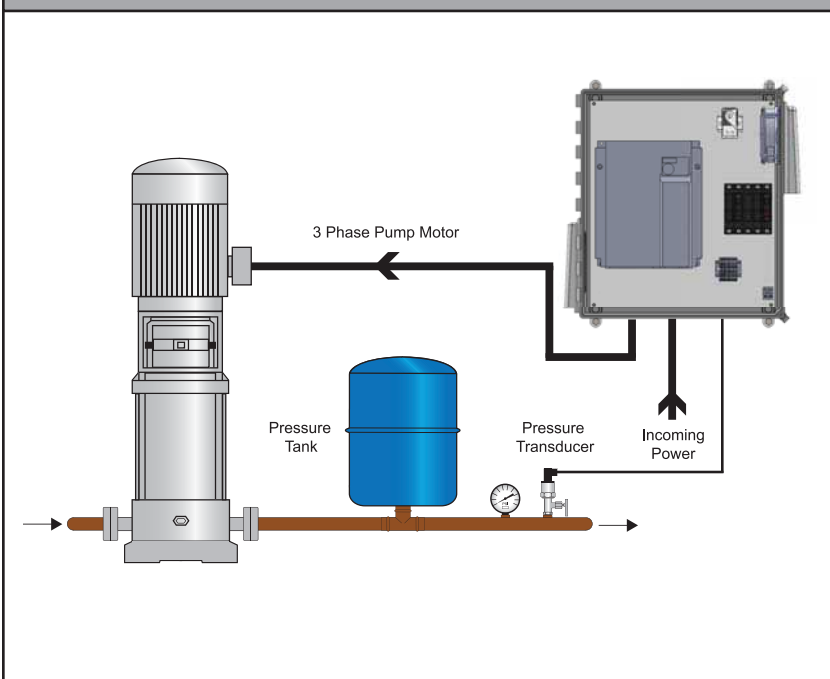



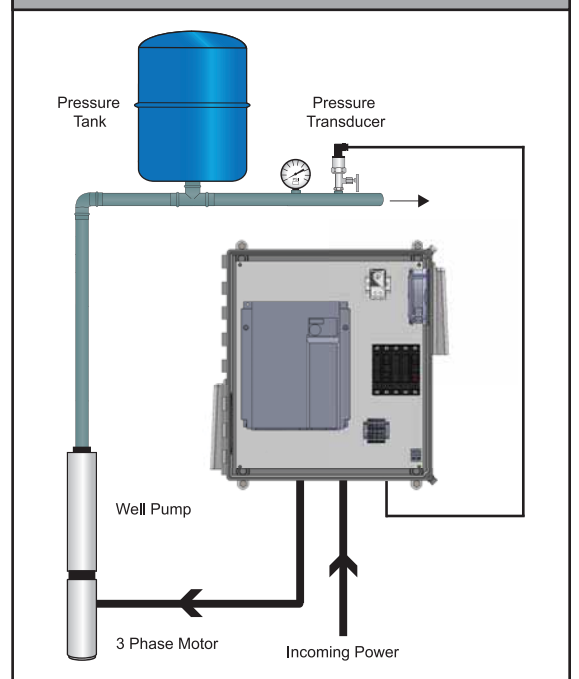

## Deep Well Submersible Pump Application



# WARNINGS

Failure to read and understand the information provided in this manual may result in personal injury or death, damage to the product or product failure. Please read each section in its entirety and be sure you understand the information provided in the section and related sections before attempting any of the procedures or operations given.

<p>Failure to follow these precautions could result in serious injury or death. Keep these instructions with warranty after installation. This product must be installed in accordance with National Electrical Code, ANSI/NFPA 70 so as to prevent moisture from entering or accumulating within the controller housing. See additional specifications on page 3 of this manual.</p>	
 <b>WARNING</b>	<b>ELECTRICAL SHOCK HAZARD</b> Disconnect power to the VARIOspeed® 3R VFD and wait 10 minutes before removing the VFD cover. A qualified service person must install and service this product according to applicable codes and electrical schematics.
	<ul style="list-style-type: none"><li>• Lethal voltages are still present inside the VARIOspeed® 3R VFD after power is disconnected. Wait 10 minutes to allow internal capacitors to fully discharge before attempting to connect or disconnect wire or to service this equipment.</li><li>• Do not connect incoming power to motor terminals 1, 2, 3. Doing so will result in irreversible damage to the drive.</li><li>• Do not connect power to this equipment if it has been damaged or has any missing parts.</li><li>• Verify that the incoming voltage supply matches the VFD rating before applying power to the unit.</li><li>• The VARIOspeed® 3R VFD contains no serviceable parts, do not attempt to repair this equipment.</li><li>• The VARIOspeed® 3R VFD must be grounded at the grounding terminal according to N.E.C. Refer to the electrical connection on page 12.</li><li>• Do not install in areas with: excessive or conductive dust, corrosive or flammable gas, excessive heat, regular impact shocks or excessive vibration.</li><li>• Do not install in areas where ambient temperature exceeds 40°C (104°F).</li></ul>
 <b>WARNING</b>	<b>EXPLOSION OR FIRE HAZARD</b> Do not use this product with flammable liquids. Do not install in hazardous locations as defined by National Electrical Code, ANSI/NFPA 70.
	

# Specification/Selection

PART NUMBER	DESCRIPTION	MODEL	OUTPUT AMPS	HP	INPUT PHASE	OUTPUT PHASE	SHIP WEIGHT
1045431	VARIOspeed® 3R, 240V	VS21-7.0-N3R	7.0	1.5	1	3	31 lbs.
1045432	VARIOspeed® 3R, 240V	VS21-10.0-N3R	10.0	3	1	3	32 lbs.
1045433	VARIOspeed® 3R, 240V	VS23-16.5-N3R	16.5	5	3	3	31 lbs.
1045434	VARIOspeed® 3R, 240V	VS23-31.8-N3R	31.8	7.5-10	3	3	35 lbs.
1045845	VARIOspeed® 3R, 480V	VS43-16.0-N3R	16.0	7.5-10	3	3	47 lbs.

**Note:** HP rating is based on standard NEMA B 4-pole motor (used for indication only, use nameplate FLA for sizing). The output voltage of the VFD cannot exceed the incoming voltage. Example: 208V in, 208V out (max).

## Selecting the Correct VFD

1. Determine the voltage available on site.
2. Select a pump with the same voltage (motor must be 3 phase).
3. Check pump motor nameplate Full Load Amps (FLA) for proper VFD sizing.
4. Select a VFD with an output amp rating higher than motor FLA.
5. Use motor Service Factor Amps (SFA) for submersible well pump applications for VFD sizing.

## Phase Conversion

It is possible to supply single phase 240V input power to VS23 models. The VFD output amp must be derated by 50%. Example: The VS23-45.0-N3R will be derated to 22.5A output (max).

\*Use three-phase input power if available. VS23 VFD's are not UL listed with single-phase supply. Always use a 3 phase motor.

## Maximum Motor Cable Lengths

For 208V-240V pumps: 400 ft. For cable lengths greater than 400 ft., use a load reactor. Do not exceed 800 ft.

For 480V pumps: 50 ft. For cable lengths greater than 50 ft., use a load reactor. Do not exceed 300 ft.

## Line/Load Reactors (Indoor/outdoor rated. Supplied separately.)

A Line Reactor is connected between the line power and VFD input. It is used for VFD protection and noise reduction.

A Load Reactor is connected between the VFD output and the motor. It is used for motor protection and noise reduction.

Mount reactors as close as possible to the VFD. Reactors will increase voltage drop, and may impact pump performance.

Consult factory for selection.

PART NUMBER	LINE/LOAD REACTORS	USE WITH MODEL	DIMENSIONS AxBxC (inches)	ELECTRICAL DATA	SHIP WEIGHT
1041535	LR23-16.5-N3R	VS21-7.0-N3R, VS21-10.0-N3R, VS23-16.5-N3R	12X12X10	18A, 0.8mH	37 lbs.
1041536	LR23-45.0-N3R	VS23-31.8-N3R, VS23-45.0-N3R	12X12X10	55A, 0.27mH	46 lbs.
1041537	LR23-58.0-N3R	VS23-58.0-N3R	12X12X10	83A, 0.17mH	47 lbs.
1041538	LR43-16.0-N3R	VS43-16.0-N3R	12X12X10	21A, 1.8mH	38 lbs.
1041539	LR43-29.5-N3R	VS43-29.5-N3R	12X12X10	35A, 0.71mH	41 lbs.

**Panel Enclosure** measures 18 x 16 x 10 inches (45.72 x 40.64 x 25.40 cm) fiberglass NEMA 3R for outdoor or indoor use with removable mounting feet & locking latch.

## Environmental

Operating temperature: 14°F to 104°F (-10°C to 40°C)

Storage temperature: -4°F to 131°F (-20°C to 55°C)

Altitude: Maximum of 3280 ft (1000m) above sea level

# Display Features and Navigation

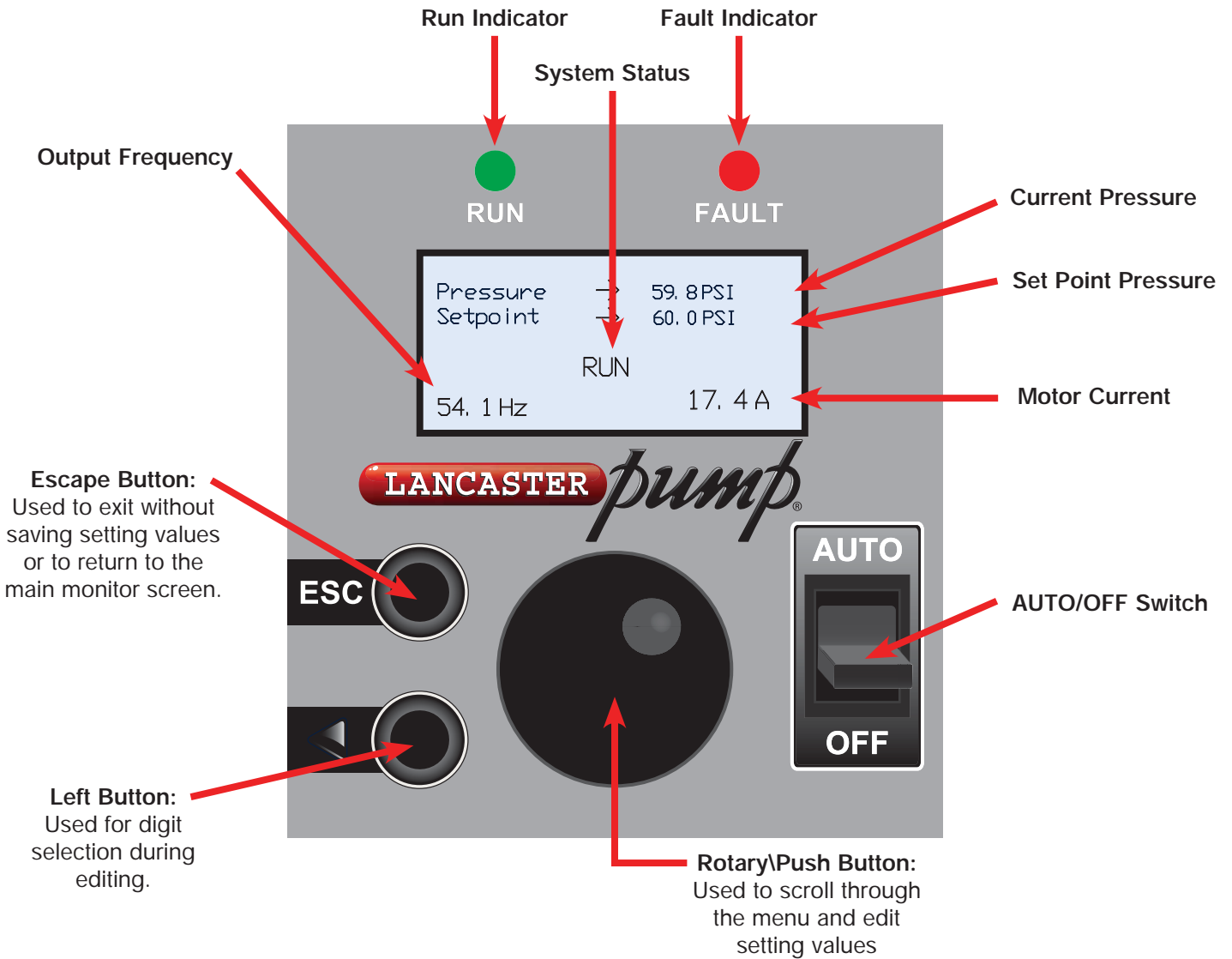

# Programming Examples

## Changing the Motor Overload Amps

1. From the main display, press the Left or Enter button to enter the settings menu.

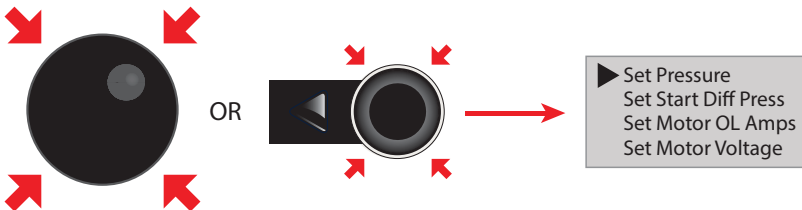

2. Rotate the rotary selector until the selection arrow highlights "Set Motor OL Amps".

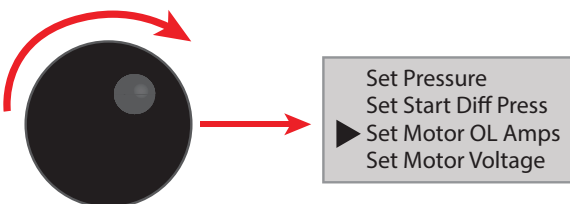

# Programming Examples

3. Press the rotary selector to enter Overload Amps editing.

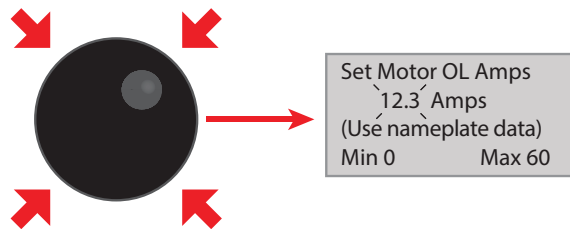

4. Rotate the selector to begin editing the value. Pressing the left arrow button will move the editing position left one digit. This is useful when making large adjustments to the edited value quickly.

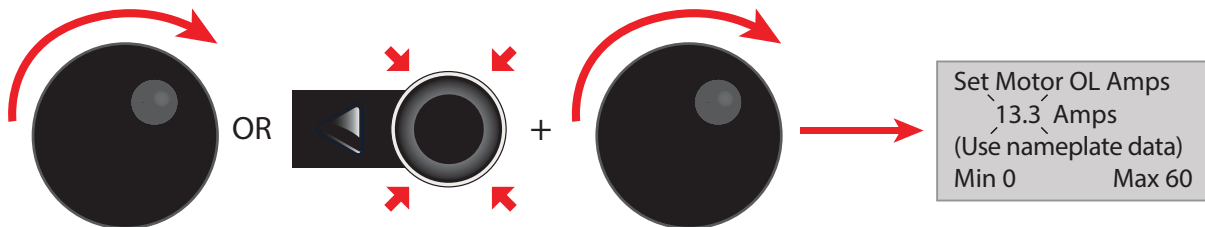

5. Press the rotary selector to save the edited value and exit the editing screen. Or press the ESC button (escape) to exit the editing screen without saving.

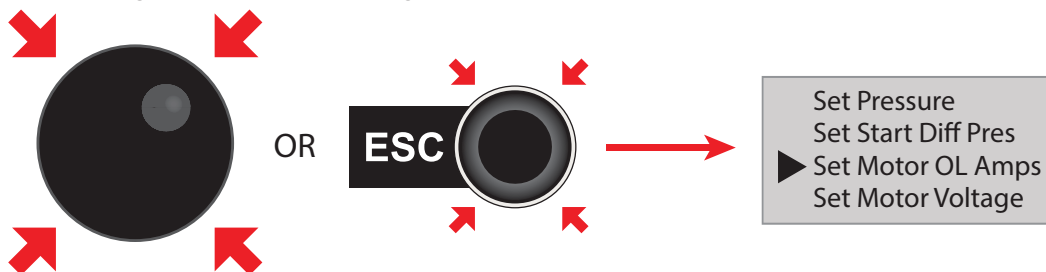

5. If no further setting needs to be edited, press the ESC button to return to the main display.

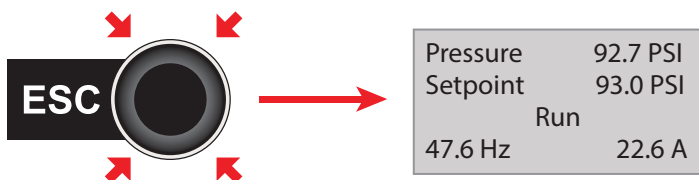

## SETUP PARAMETER + LOG MENU

Set Pressure	Set PID Prop Term	Set High Press Alarm
Set Start Diff Pres	Set PID Integ Term	Set Run Dry Press
Set Motor OL Amps	Set 1st Accel Time	Set Run Dry Delay
Set Motor Voltage	Set 1st Decel Time	Set Run Dry Restart
Set Sleep Frequency	Set Accel 2 Sw Freq	View Run Time
Set Sleep Time	Set Acc/Dec Time	View VFD Fault Hist
Set Xducer Max Rng		View System Fault Log
Set Min Frequency		
Set Max Frequency		

# OFF/AUTO Operation

## OFF position

The pump will not run.

## AUTO position

The pump will not run if the pressure is above the Set Pressure. The pump will start automatically if the pressure drops below the Set Pressure less the Start Diff. Press. Example: If the Set Pressure is 40 PSI, and the Start Diff. Pressure is 5 PSI. The pump will start when the pressure drops below 35 PSI (see example below).

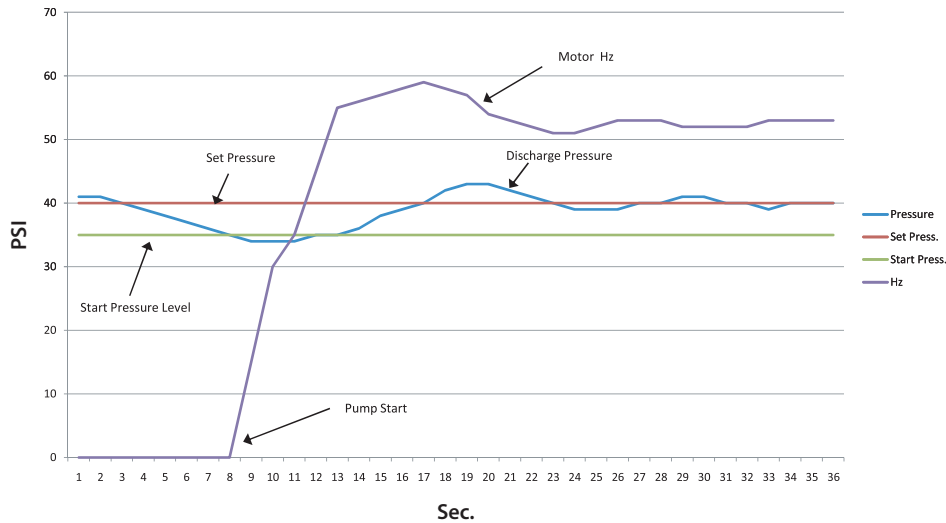

## Pressure Transducer Fail Shutdown

In the event that the pressure transducer signal should be lost, the system will shut the pump off. During the transducer fail error, the display will flash "SENSOR FAILURE" on the main display and the fault indicator will illuminate. If the transducer failure is corrected, the display will return to its normal condition and normal pressure control will resume.

# Parameter Setup List

SETTING DESCRIPTION	RANGE	DEFAULT
Set Pressure	0 to "Xducer Max Range" -0.1	60.0 PSI
Start Diff. Pressure	0 to "Set Pressure" -1	5 PSI
Motor OL Amps	0 to VFD Amp Rating	Model Specific
Motor Voltage	0 to 1000 Volts	Model Specific (230/460 VAC)
Sleep Frequency	0 to "Max Frequency"	35.0 Hz
Sleep Time	0 to 3600 seconds	10 seconds
Xducer Max Range	0 to 1000 PSI	200 PSI
Min Frequency	0 to "Max Frequency"	30.0 Hz
Max Frequency	"Min Frequency" to 120 Hz	60.0 HZ
PID Proportional Term	0.1 to 1000%	100.0%
PID Integral Term	0.1 to 3600 seconds	1.0 seconds
1st Accel Time	0 to 3600 seconds	2 seconds
1st Decel Time	0 to 3600 seconds	2 seconds
Accel 2 Switchover Freq	0 to "Max Frequency"	30 Hz
Accel/Decel Time	0 to 3600 seconds	3 seconds
High Pressure Alarm	0 to "Xducer Max Range" - 0.1	90.0 PSI
Run Dry Pressure	0 to "Set Pressure" -1	15 PSI
Run Dry Delay Time	0 to 6.0 minutes	0.5 minutes
Run Dry Restart Time	0 to 999.9 minutes	0.0 minutes (manual restart)

# Parameter Setup List

## Set Pressure

Set Pressure is the target pressure to be maintained at the pump discharge. It cannot exceed the maximum range of the pressure transducer.

## Start Diff. Pressure

The Start Diff. Pressure is the amount of pressure drop from the Set Pressure, at which the VFD will wake from sleep and run to maintain the system pressure. The pump will start if the pressure drops below the Set Pressure less the Start Diff. Pressure. Example: If the Set Pressure is 40 PSI and the Start Diff. Pressure is 5 PSI, the pump will start when the pressure drops below 35 PSI.

## Motor OL Amps

The VFD's electronic overload will signal an overload fault and protect the motor from damage in the event of an overload condition. Set the Motor OL Amps setting to the motor nameplate Full Load Amps for non-submersible pumps and to the Motor Max Amps for submersible pumps.

## Motor Voltage

Set the Motor Voltage setting to the voltage rating found on the motor nameplate. This value must not exceed the voltage of the incoming power.

## Sleep Frequency

Set the Sleep Frequency to the frequency at which the pump no longer builds pressure when operating at or near the Set Pressure. The VFD will enter the "sleep" mode when the output frequency of the VFD drops below the Sleep Frequency for a period of time (Sleep Time).

## Sleep Time

Set the Sleep Time to the amount of time that the VFD will wait before entering "Sleep" mode after the output frequency drops below the Sleep Frequency. Note: If the system cycles on and off too frequently, try the following: increase the Sleep Time, lower the Sleep Frequency, or increase the Start Pressure. A combination of changes of all three settings may be necessary. If the VFD does not enter "Sleep" mode when there is no flow of water in the system, the Sleep Frequency must be increased.

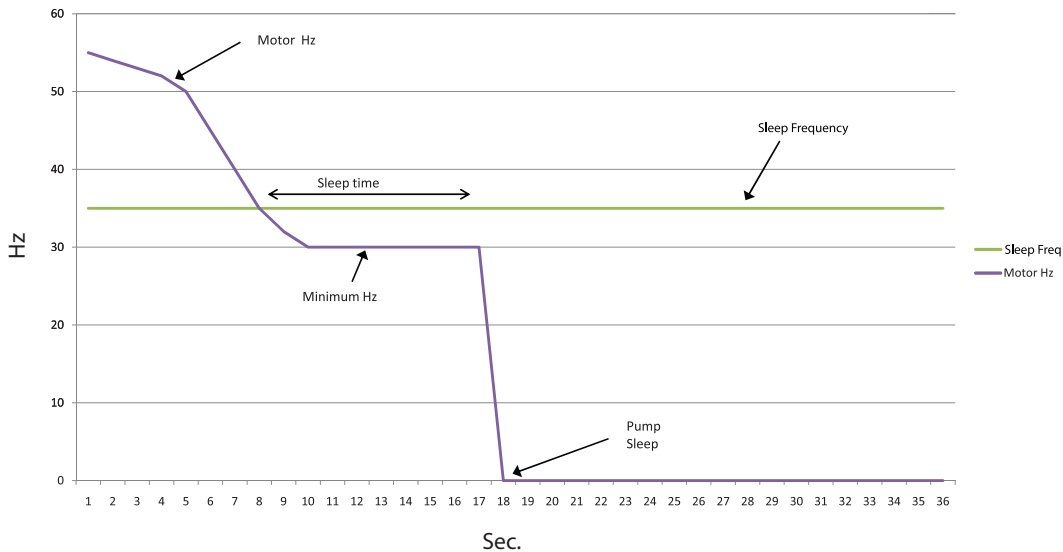

## Xducer Max Range

If using a different transducer other than supplied, set the Xducer Max Range to the full span rating of the pressure transducer. The Set Pressure and Start Diff. Pressure values must also be updated after changing the Xducer Max Range, as these values are automatically scaled based on the Xducer Max Range.

## Min Frequency

The Min Frequency should be set to the minimum output frequency that the pump should be allowed to run. Contact your pump manufacturer to obtain the pump safe operation ranges.

# Parameter Setup List

---

## Max Frequency

The Max Frequency should be set to the maximum output frequency that the pump should be allowed to run. Contact your pump and motor manufacturer for operation above 60 Hz.

## PID Proportional Term

The PID Proportional Term is intended to be adjusted by **advanced** users only. The PID Proportional Term is used to adjust the reaction of the output frequency to changes in the system pressure. Decreasing the PID Proportional Term will allow the VFD to make larger corrections to the output frequency with differences between the Set Pressure and actual system pressure. Increasing the PID Proportional Term will allow the VFD to make smaller corrections to the output frequency with differences between the Set Pressure and actual system pressure.

## PID Integral Term

The PID Integral Term is intended to be adjusted by **advanced** users only. The PID Integral Term is used to adjust how quickly the output frequency reacts to changes in the system pressure. Decreasing the PID Integral Term will allow the VFD to make quicker corrections to the output frequency with differences between the Set Pressure and actual system pressure. Increasing the PID Integral Term will allow the VFD to make slower corrections to the output frequency with differences between the Set Pressure and actual system pressure.

## 1st Accel Time

Set the 1st Accel Time to the rate at which the output frequency will accelerate from 0 Hz to the Accel 2 Switchover Frequency. This time is based on the time the VFD would take to accelerate from 0 Hz to 60 Hz. Example: If the pump is required to accelerate from stop to 30 Hz in 1 second the 1st Accel Time should be set to 2 seconds.

## 1st Decel Time

Set the 1st Decel Time to the rate at which the output frequency will decelerate from the Accel 2 Switchover Frequency to a stop. This rate is based on the time the VFD would take to decelerate from 60 Hz to 0 Hz. Example: If the pump is required to decelerate from 30 Hz to a stop in 4 seconds the 1st Decel Time should be set to 8 seconds.

## Accel 2 Switchover Frequency

The Accel 2 Switchover Frequency should be set to the frequency at which the acceleration and deceleration rates change. This is typically used on submersible type pumps, where the manufacturer requires a fast acceleration from a stop to 30 Hz for proper thrust bearing operation.

## Accel/Decel Time

Set the Accel/Decel Time to the rate at which the output frequency will change as the VFD is operating above the Accel 2 Switchover Frequency. This time is based on the time the VFD would take to accelerate or decelerate between 0 Hz to 60 Hz.

## High Pressure

Set the High Pressure Alarm setting to the pressure at which the VFD output will shut off due to high system pressure. There is a 2 second delay before the VFD will activate the High Pressure Alarm. If system pressure drops below the High Pressure alarm setting for 10 seconds, the high pressure alarm will automatically reset and normal operation of the VFD will resume.

## Run Dry Pressure

Set the Dry Run Pressure to the low pressure setting that will indicate the pump cannot build pressure due to the lack of supply water. The VFD must be running at maximum output frequency and the system pressure must be below the Dry Run Pressure for the amount of time set in Dry Run Delay Time for the VFD to stop due to a Dry Run Alarm.

## Run Dry Delay Time

Set the Dry Run Delay Time to the amount of time the VFD must be running at maximum output frequency while the system pressure is below the Dry Run Pressure, before the VFD will stop due to a dry run alarm.

## Run Dry Restart Time

Set the Dry Run Restart Time to the amount of time the VFD will remain stopped due to a Dry Run alarm, before restarting. This time allows the well or water source to "recharge" before the system restarts. If a manual restart is desired, set the Dry Run Restart Time to "0.0". For a manual restart of the system, the "ESC" button must be pressed for 2 seconds, or the power must be cycled. The display will indicate "Dry Run Fault" if a manual restart is required.



# Pressure Tank/Pressure Relief Valve/Low Pressure

To maintain constant pressure and prevent frequent startup, a small-capacity pressure tank is needed in the system (refer to the minimum capacity of pressure tank table below). The VARIOspeed® 3R control panel may use a pressure tank of a larger capacity than listed on the table below.

## Minimum Capacity of Pressure Tank

Flow Rate (GPM)	Tank Size (Total Capacity)
Less than 12.0	4 Gallons
More than 12.0	8 Gallons
More than 50.0	14 Gallons

## Pre-Charge Pressure

1. Initial charge pressure should be set at 70% of the system pressure (Set pressure).
2. To maintain the optimum pressure control, check the air pressure in the tank regularly.

Set Pressure (PSI)	Initial Charging Pressure (PSI)
50 (default)	35
55	39
60	42
65	46

## A Pressure Relief Valve Must be Installed.

A pressure relief valve **MUST** be installed as close as possible to the pump discharge and plumbed to a drain able to handle the full flow of the pump in the event of a malfunction.

### **WARNING!**

Failure to use a pressure relief valve could result in burst pipes and flooding if a system failure should occur.

# Faults, Alarms and Warning Codes

MAIN DISPLAY MESSAGE	DESCRIPTION OF FAULT ALARM
COMMUNICATION LOST	Loss of Communications
SENSOR FAILURE	Pressure Sensor Fault
HIGH PRESS WARNING	High Pressure Warning
RUN DRY WARNING	Run Dry Warning (Automatic Reset)
RUN DRY FAULT	Run Dry Fault (Manual Reset required)
OVER CURR ACCEL	E.OC1 Overcurrent Trip During Acceleration
OVER CURRENT	E.OC2 Overcurrent Trip During Constant Speed
OVER CURR DECEL	E.OC3 Overcurrent Trip During Deceleration
OVER VOLTAGE 1	E.OV1 Regenerative Overvoltage
OVER VOLTAGE 2	E.OV2 Regenerative Overvoltage
OVER VOLTAGE 3	E.OV3 Regenerative Overvoltage Trip
VFD OVERLOAD TRIP	E.THT Inverter Overload Trip
MOTOR OVERLOAD TRIP	E.THM Motor Overload Trip
VFD OVERHEAT	E.FIN Fin Overheat
STALL PREVENTION	E.OLT Stall Prevention
GROUND FAULT	E.GF Output Side Earth (ground)
OUTPUT PHASE LOSS	E.LF Output Phase Loss
INRUSH CURRENT LIMIT	E.IOH Inrush Current Limit Circuit
INVALID ANALOG INPUT	E.AIE Analog Input Fault
INPUT PHASE LOSS	E.ILF Input Phase Loss
BRAKE XSTR ALARM	E.BE Break Transistor Alarm Detection
XTRNL THERMAL OVLD	E.OHT External Thermal Relay Operation
XTRNL THERMIST TRIP	E.PTC PTC Thermistor Operation
VFD EEPROM FAULT	E.PE Parameter Storage Device Fault
DISCONNECTED PU	E.PUE PU Disconnection
FAULT RETRY EXCEEDED	E.RET Retry Count Excess
VFD CPU FAULT	E.5/E.CPU CPU fault
OUTPUT AMPS DETECT	E.CDO Output Current Detection Value Exceeded
SAFETY CIRCUIT FAULT	E.SAF Safety Circuit Fault

## IMPORTANT:

Faults can be reset by pressing the STOP/RESET button on the VFD. The OFF/AUTO selector switch must be in the "OFF" position when resetting any fault. Please contact your distributor if you are unable to reset a fault by removing power from the VFD and repowering after one minute.

# Viewing Log

## Viewing Pump Motor Run Time

Pump Motor Run Time  
1234567 hours

The accumulated run time of the motor can be viewed by accessing the View Run Time screen in the setting menu. The run time is displayed in total hours run.

## Viewing VFD Fault History

VFD OVERLOAD TRIP  
STALL PREVENTION  
VFD OVERLOAD TRIP  
VFD OVERLOAD TRIP

The VFD fault history can be viewed by accessing the VFD Fault History screen in the settings menu. The last eight faults can be viewed by scrolling through the VFD Fault History screen, with the most recent faults first. If a fault is currently active, the fault will flash on the main screen.

## Viewing System Fault Log

-- Time Since Fault --  
H. Press      42d 16:23:42  
Run Dry        No Faults  
Sensor         No Faults

The System Fault Log can be viewed by accessing the View Sys Fault Log screen in the settings menu. The System Fault Log shows the length of time since a HIGH PRESSURE CONDITION, DRY RUN CONDITION, or SENSOR FAILURE occurred. If no fault has occurred, the "No Faults" message is shown.

# Terminal Connections

## 240 VAC PANELS

**NOTE:** When connecting single-phase power, use terminals L1 and L2 only. Terminal L3 is left unused.

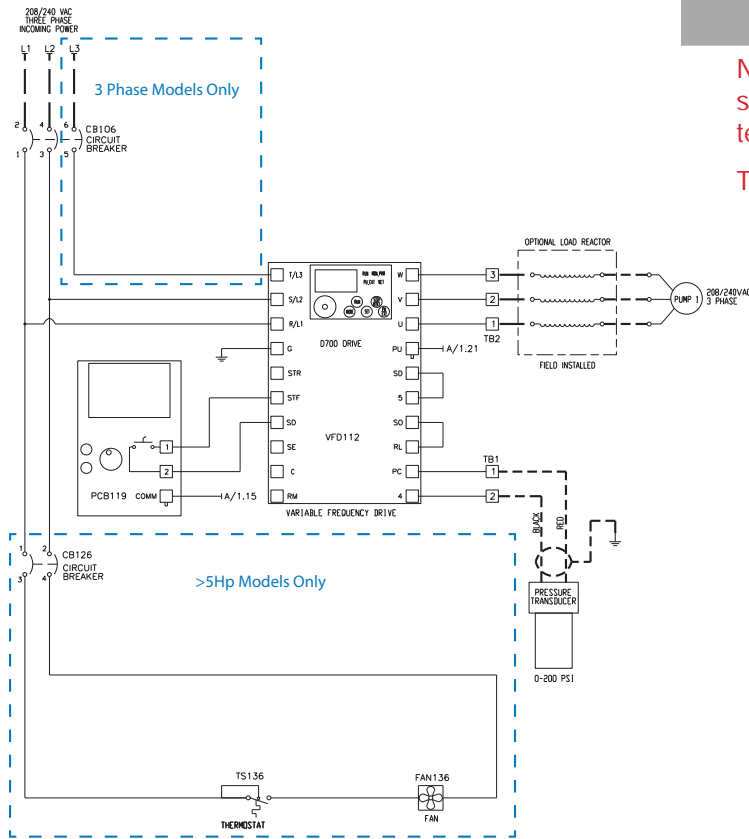

## 480 VAC PANELS

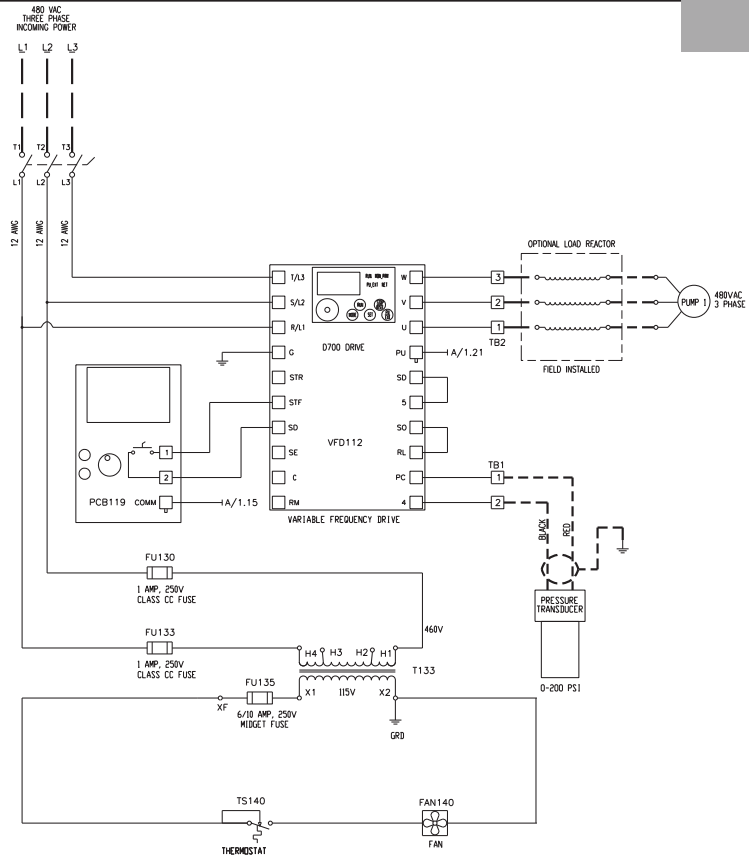

# Installation

