

INSTALLATION, OPERATING AND SERVICE MANUAL

LANCASTER JET PUMPS

SHALLOW WELL ◊ CONVERTIBLE (SHALLOW OR DEEP WELL) ◊ DEEP WELL

CAREFULLY READ THE LITERATURE PROVIDED BEFORE INSTALLATION!

LANCASTER PUMP recommends an experienced water-well serviceman to install new water systems or replace an existing jet pump or pump motor. This manual should be retained for future reference.

INSPECT THE NEW PUMP:

Occasionally, products are damaged during shipment. If the product is damaged, contact the transportation company or your dealer. Save the product's packing materials until claim is settled. The package includes pump, motor and pressure switch. Convertible and deep well pumps do not include an injector, but an injector is required and must be purchased separately. Make sure motor electrical rating matches available electrical power supply.

SAFETY INSTRUCTIONS

- WARNING - HAZARDOUS PRESSURE.** Jet pumps can develop high pressure. Do not run the pump with the discharge completely closed. Install a pressure relief valve capable of passing entire flow at 75 PSI. Never work on pump or system without relieving the internal pressure.
- WARNING - HAZARDOUS VOLTAGE.** Voltage can shock, burn or cause death. Install, ground and wire pump according to local and national electrical code requirements that apply. Single phase motors are equipped with automatic resetting thermal protectors. The motor may re-start unexpectedly causing the leads to energize or pump to turn. **DISCONNECT ELECTRICAL POWER SUPPLY BEFORE INSTALLING OR SERVICING THE PUMP.** Capacitor voltage may be hazardous. To discharge motor capacitor, hold insulated handle screwdriver (**BY THE HANDLE**) and short the capacitor terminals together. Do not touch metal screwdriver blade or capacitor terminals. **A QUALIFIED ELECTRICIAN IS RECOMMENDED.**
- Install pump according to all plumbing, pump and well code requirements.
- Do not run pump dry. Pump can be severely damaged if run dry. Pump only water with this pump. Do not pump water above 120°F. Do not allow pump, pressure tank, piping or any other system component to freeze. Freezing may damage system, leading to injury or flooding.
- Test well for purity before using well. Call your local health department for testing requirements.
- During installation, keep well covered as much as possible to prevent leaves and foreign matter from falling into well.
- Pipe joint compound can cause cracking in plastics. Use only Teflon tape when sealing threads in plastic pipe.

MAKE SURE THE CORRECT JET PUMP SYSTEM HAS BEEN SELECTED

A jet pump is a centrifugal pump with a jet (injector) assembly. **LANCASTER PUMP** manufactures three types of jet pumps:

- SHALLOW WELL JET PUMPS** (single or dual stage) with built-in or bolted on injectors for maximum suction lift of 25'. (See figure 1)
- CONVERTIBLE JET PUMPS** (single stage) can be used for shallow wells (to 25' lift) using an injector bolted onto pump body; or deep wells (more than 25' lift) with injector in the well. (See figures 2A,2B)
- DEEP WELL JET PUMPS** (dual stage) are **ONLY** used for deep wells (more than 25' lift) with the appropriate injector in the well. (See figure 2B)

ALWAYS CONSULT DEALER/DISTRIBUTOR/FACTORY FOR THE BEST APPLICABLE PUMP SYSTEM .

Dealer or Homeowner: Record the following information for future reference:	
Pump Model No.	For Convertible & Deep Well Pumps Only -
Pump Serial No.	Injector No.
Date of Installation	(purchased separately)

PRE-INSTALLATION PREPARATION

THE WELL - Pump performance is based on pumping clear, cold water with no entrained air. The well driller should properly develop the well, i.e. pump out all fine sand, dirt and foreign matter, before the pump is installed. The water level in the well should be measured to assure that it will not drawdown below the maximum pumping depth of the jet pump system selected. This should be done by the well driller, who can also furnish the amount of water the well produces at this pumping depth. Be sure the well is capable of supplying water in excess of the jet pump capacity. There are three basic types of wells:

- A. Dug or Bored Well (or Cistern) - see figures 4A, 4B
- B. Driven Well with well point - see figures 5A, 5B
- C. Drilled Well - see figures 1 thru 3

Chlorinating the well may be required before installing a new pump. Check with local health department for recommendations.

Pumping from a lake, river or spring can also be considered - see figures 6A, 6B

LOCATION - The pump, pressure tank and electrical controls should be installed in any convenient location that provides sufficient space for installation and servicing. A clean dry basement, pit or utility room to avoid dampness and temperature extremes are excellent choices when allowed by law. Check with state and local agencies to determine restrictions in your area. In any installation where the pump pressure could exceed the water storage tank pressure, provide a pressure relief valve piped to a suitable drain.

PIPE CONNECTIONS - Always follow state and local plumbing codes. Lancaster Pump does not sell or specify pipe types or materials, consult with your pipe supplier to determine the best pipe for your installation. Pipes can be threaded, glued, soldered or clamped to available fittings and adaptors. If using poly pipe with barbed connectors, we suggest you double clamp all fittings to prevent air leaks. **BE SURE ALL SUCTION CONNECTIONS ARE AIRTIGHT.** The primary cause of problems in a new installation is air leaks in one or more joints in the suction line. Use Teflon tape on male threads of plastic pipe. Do not use pipe joint compound on plastic piping because it will damage piping (crack) over time. All pipes should be carefully cleaned so they are free from scale or dirt. A leaking foot valve due to dirt or scale may allow pump to lose prime and cause pump failure. Check all pipe threads to be sure they are sharp and properly cut.

HELPFUL HINTS

- Install pump as close to the well head as possible. On offsets more than 50 feet (distance between the well and pump) increase pipe one size and then reduce again at pump. This will reduce friction losses. Never use pipe size smaller than the pump tapped sizes.
- Never route the piping up above and then down to the pump suction, causing air pockets in the suction pipe. Suction piping should be either level straight from the well to the pump or should slope upward to the pump. Use as few elbows and fittings as possible. Support the weight of the pipe.
- For ease of installation and service, install unions or slip couplings on suction and discharge side of system.
- Provide a drain cock at a low point in the service line to drain the pressure tank. If the pump is to be inactive for any length of time, it is advisable to completely drain the system. This will prevent freezing. To drain the pump before disconnecting for service or to protect from freezing, first remove the drain plug from the bottom of the pump body. Next remove the priming plug to vent the pump. Drain all piping to a point below the freeze line.

ELECTRICAL CONNECTIONS - **Wiring to this pump must be installed and maintained in accordance with both the National Electrical Code and state/local codes. A qualified electrician is recommended.**

Make sure motor voltage rating matches available power supply voltage. See the motor nameplate. Dual voltage motors have a sticker on them that identifies the factory pre-wired voltage. If needed, the motor voltage is changed inside the motor cover, not at the pressure switch. See the motor nameplate for instruction. Make sure the breaker or disconnect is OFF before entering the motor cover.

Properly sized copper wire from service to motor will avoid over-heating wire and excessive voltage drop at the motor. Pump should be connected to a separate branch circuit with no other appliances on it. Consult dealer or electrician.

MAJOR COMPONENTS AND THEIR FUNCTIONS (see figures 1 thru 3)

PRESSURE TANK - The pressure tank serves two functions: (1) It provides a reservoir of water, some of which can be drawn through the house fixtures before the pump must start. (2) It maintains a cushion of air under pressure to prevent pipe hammering and possible damage to plumbing.

- A **Pre-charged bladder tank** is a tank having a permanent pre-charge of air. Read further in this manual for proper air pre-charge and adjusting if necessary.
- A **Non-bladder type tank** uses an air volume control to add air to the tank as needed. The air volume control is hooked to the side of the tank and a pressure tube is connected from the air volume control to the suction side of the pump.

PRESSURE SWITCH - The pressure switch provides for automatic operation. The pump starts when the pressure drops to the cut-in setting and stops when the pressure reaches the cut-out setting.

PUMP IMPELLER, INJECTOR AND CONTROL VALVE - The impeller is located inside the pump body and rotates with the motor shaft, causing an increase in water pressure. The rotation of the impeller creates a vacuum, allowing water to be drawn in. Part of the water exiting the impeller goes to discharge, and some of the water is diverted back to the injector, where it again passes through a nozzle and venturi, creating additional vacuum to draw in more water and deliver it again at high pressure to the impeller.

- In a **DEEP WELL** installation, the injector is submerged in the well because the vertical distance to the water level exceeds the suction lift of the pump. Adjustment of a **control valve**, attached to the pump discharge side, causes the right amount of water to be diverted back to the injector for the most efficient operation.
- In a **SHALLOW WELL** installation, the injector is either built-in the pump or attached directly to the pump because a vacuum will lift water to the pump. A **control valve** is not necessary for shallow well installations, but could be used to restrict discharge flow if the pump has the capacity to draw more water than the well can produce.

MOTOR - Follow the motor manufacturer's recommendation for lubrication. Generally, the bearings are permanently lubricated.

SHALLOW WELL INSTALLATION (see figures 1, 2A)

SUCTION PIPING - The suction pipe should be at least as large as the pump suction, usually 1¼". Avoid using smaller pipe size because the friction losses increase thereby decreasing flow and pressure. Refer to "**Pre-Installation**" section of this manual, and review "**Pipe Connections**" and "**Helpful Hints**" again to properly route suction pipe.

Install a foot valve on the end of your drop pipe if the well is 2" or larger. Lower the drop pipe with foot valve into the well. Keep at least 5' off the bottom of a clean well. If you set it lower you increase the possibility of pulling debris into the screen or into the pump.

On sand points or driven wells, install an in-line check valve near the well head or at the pump and use the well casing as the suction pipe. (see figure 5A) The closer the check valve is to the well, the easier the system will prime.

In areas where freezing occurs, make the transition from vertical to horizontal below the frost line using a pitless adapter. In some areas, a well seal and a 90° elbow is used.

Do not use filters on the suction side of a jet pump. Dirty filters will increase the effective suction lift on the pump and can starve the pump of water. This will damage the pump impeller and diffuser.

Shallow well jet pumps have an injector already bolted on to the pump body or the injector is built-in the pump body. Convertible jet pumps used on shallow wells require you to install the injector (purchased separately) onto the pump body. A gasket is placed between the pump body front flange and the injector. Tighten the bolts evenly to insure proper sealing and alignment of the injector venturi tube to the pump impeller.

Attach suction piping to pump.

DISCHARGE PIPING - Install a tee in the pump discharge (tee not supplied with pump). Install a pipe plug or a pressure gauge (into a reducer bushing) in the top port of the tee. This will be used as the priming port. Do not place valves (check valves) or filters between the pump and pressure tank, other than a fully open gate valve or "full port" ball valve. The most common ball valves are not full port! Most valves and filters will cause excessive friction loss and cause "switch chatter", i.e. a rapid on-off cycling of the pressure switch and pump motor. It will burn the points in the switch and cause motor (and pump) damage if not corrected. If you must have valves or filters between the pump and tank, and they cause switch chatter, move the pressure switch to the tank cross tee.

Go to "**CONNECTING TO PRESSURE TANK**" section of this manual to complete shallow well installation.

TWIN PIPE DEEP WELL INSTALLATION (see figure 2B)

TWIN PIPE SUCTION PIPING - A twin pipe injector installation is used in wells 4" and larger. The injector requires a minimum 1¼" suction pipe and 1" drive water pipe. Refer to "Pre-Installation" section of this manual, and review "Pipe Connections" and "Helpful Hints" again to properly route suction piping.

Check to make sure the nozzle and venturi tube are installed in the injector body. Attach the 1¼" suction and 1" drive water (pressure) pipe to the injector female threads. Install a foot valve on the single bottom port of the injector.

Lower the injector assembly into the well. It should be set at least 10' below the lowest anticipated water level. Keep the injector 5' off the well bottom to reduce the risk of sucking debris into the injector. The connections at the well head can be either a pitless adaptor or a well seal. Priming will be easier if you fill the pipes with water before attaching the pump.

Connect the suction and drive water (pressure) pipes to the threaded connections on the face of the pump.

Go to "Deep Well Discharge Piping" section of this manual.

PACKER DEEP WELL INSTALLATION (see figure 3)

PACKER SUCTION PIPING - Packers use the area between the well casing and the suction pipe as the drive water (pressure) pipe. The 2" well casing must be smooth and clean to insure a good seal with the packer leathers or the system will leak and not hold prime.

The single pipe injector consist of a nozzle and venturi in a packer body with packer leathers and foot valve. The packer leathers are cup shaped and their lips should be facing the injector. To ease installation, soak the packer assembly in warm water to make the leathers soft and pliable. **DO NOT** lubricate them with grease, oil or petroleum jelly! The leathers must absorb water to seal the packer assembly against the well casing.

Attach the 1¼" suction pipe. Use turned couplings (1-13/16" O.D.) to connect the sections of 1¼" threaded pipe. This special turned diameter coupling increases the clearance between the 2" well I.D. and the O.D. of the coupling to allow the drive (pressure) water to easily pass the couplings. Failure to use them will decrease pump pressure and flow, and the pump may easily lose prime! Lower the packer assembly (foot valve, packer, injector) into the well casing. Pushing packer assembly down, add pipe sections using turned couplings, and fill pipe with clean water after each pipe length to help check for leaks. Continue lowering assembly until it reaches a depth of 10-20' below the lowest anticipated water level. Make sure that foot valve is at least 5' above bottom of well.

ATTACH SUCTION PIPE TO WELL CASING ADAPTER - Packer systems require an offset casing adapter at the well head. The adapter makes the transition from vertical to horizontal. After the packer assembly is inserted into the well, attach the 2" well casing adapter to the top of the 1¼" suction pipe. Screw the top section of 1¼" male threaded suction pipe into the 1¼" NPT female threaded hole in the 2" well casing adapter. Make sure that the O.D. of the 2" well casing is free of dirt and burrs. With the flange bolts loosened, the seal ring in the casing adapter should slide over the well casing. Making sure the seal ring is in place, tighten the two bolts to compress the seal ring and seal it to the well casing O.D. The pump can be attached to the casing adapter using two bolts and a gasket (provided with pump).

DEEP WELL DISCHARGE PIPING (see figures 2B, 3)

Deep well jet pump installations need back pressure to operate the injector. A control valve or some type of flow restrictor must be installed in the discharge line to provide this back pressure. The valve must be located between the pump and first discharge point. The best valve location is as close to the pump as possible. If a control valve is not installed and adjusted, loss of prime during peak demand, such as filling washing machines and bathtubs will occur.

A ball valve or gate valve could be used as a control valve. Lancaster Pump offers as an accessory item, a control valve with built-in priming port, locking adjustment control and ¼" NPT pressure line tapping. This control valve's pressure line tapping allows the pressure switch to read the pressure on the discharge side of the valve rather than in the pump body. This control valve can be installed directly onto pump discharge. Do not place other check valves or filters between the pump and pressure tank, other than a fully open gate valve or "full port" ball valve. Additional valves and filters will cause excessive friction loss and cause "switch chatter" i.e. short cycling. If you must have other valves and filters between the pump and tank, move the pressure switch to the tank cross tee.

CONNECTING TO PRESSURE TANK (see figure 1 thru 3)

While the pre-charged tank is empty, check the pre-charge air pressure with a tire pressure gauge. The tank pre-charge should be adjusted to 2 PSI lower than the pump cut-in (turn on) pressure switch setting. Lancaster Pump jet pumps are supplied with pressure switches factory pre-set to 20-40 (cut in-cut out) PSI. Pressure switches are field adjustable. Install a pressure relief valve capable of passing entire flow at 75 PSI. Make the piping connections between the pump discharge and the tank. Complete the piping by connecting to the house plumbing.

Galvanized steel tanks are installed the same as pre-charged tanks except they require an Air Volume Control (AVC) to replace air lost through absorption. The AVC is connected to the side of the galvanized tank, and a tube is connected from the AVC to a vacuum port on the pump. Follow instructions supplied with AVC.

CONNECTING PRESSURE SWITCH & POWER

Make sure the power supply breaker or disconnect is OFF before working on pumps, motors and switches!

Review the “**Electrical Connections**” portion of the “**Pre-Installation Preparation**” section of this manual before continuing further.

Remove the pressure switch cover. Attach the ground wire first! Connect the ground lead from the service panel ground to the green ground screw in the switch. There may be two green ground terminals in the switch; connect to either one. Now connect the power supply leads to switch terminals marked LINE, L or L1/L2. For 115 volt installations, it makes no difference which line terminal you attach the hot-L1 (usually black) and neutral-N (usually white) 115 volt wires to on the switch. The same goes for a 230 volt hook-up, either wire can go on either Line terminal. Motor leads should be connected to switch terminals marked LOAD, MOTOR, M1/M2 or T1/T2. Make sure a motor ground wire is connected to ground terminal in switch. Replace the pressure switch cover. Pump is now wired for operation.

OPERATION

Caution: Do not run pump dry. Pump can be severely damaged if run dry!

PRIMING THE PUMP - To prime the pump, remove the pipe plug or pressure gauge bushing in the discharge tee. Fill suction piping and pump with water until the water overflows from top of tee. Replace plug or bushing and tighten to seal. Install pressure gauge in bushing. Open the faucet closest to the pump/tank so a small amount of air can escape the system. Do not open faucet too much or the pump will expel too much water and you will have to re-prime the pump. On installations with long suction pipes, you may have to add water to the pump body several times to complete the priming process. On deep well installations, filling the suction and drive water pipes with water **before** installing the pump will make priming faster and easier. Before operating the pump on a deep well installation, be sure to **almost** completely close the control valve. Start motor. If pump does not prime within 5 minutes, stop the motor. Repeat the process of adding water in the pump. When prime is established, the pressure gauge will read high pressure. **Immediately** begin to open the deep well pump's control valve slowly and adjust to a maximum flow at a minimum pressure in the pump body **capable of maintaining prime**. If the pump should lose prime, repeat the process, taking care to open the control valve more slowly. Make this adjustment with water discharging freely so tank pressure will not influence gauge reading. On wells having excessive draw-down, it may be necessary to set the control valve for slightly higher pressure gauge reading.

CAUTION: Make sure the pressure switch is set low enough to shut off the pump. If the pressure switch setting is too high, or the control valve is closed, the pump will run continuously without water flow. This will overheat and damage the pump. After all the aforementioned is established, pressure can now build-up to the cut-off pressure of the pressure switch setting. The system should now operate automatically.

BOOSTER SYSTEMS

Shallow well jet pumps or convertible jet pumps with an injector bolted onto it, can be used as pressure booster pumps. See Figure 7 showing a city water booster system installation.

**FIGURE 1-
SHALLOW WELL JET PUMP (SINGLE OR DUAL STAGE)
SHALLOW WELL SYSTEM**

25 FEET OR LESS TOTAL SUCTION LIFT =
PUMP TO WATER DEPTH + SUCTION PIPE FRICTION LOSS

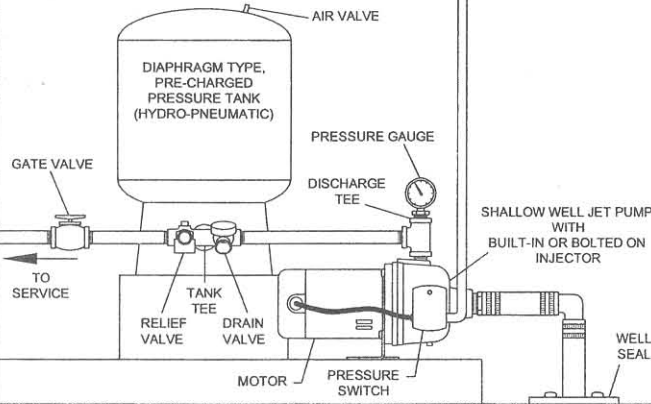

NOTE: DURING INSTALLATION, WHILE THE PRE-CHARGED TANK IS EMPTY, CHECK THE PRE-CHARGE AIR PRESSURE WITH A TIRE PRESSURE GAUGE. THE TANK PRE-CHARGE SHOULD BE ADJUSTED TO 2 PSI LOWER THAN THE PUMP CUT-IN (TURN ON) PRESSURE SWITCH SETTING. LANCASTER PUMP JET PUMPS ARE SUPPLIED WITH PRESSURE SWITCHES FACTORY PRE-SET TO 20-40 (CUT IN-CUT OUT) PSI. PRESSURE SWITCHES ARE FIELD ADJUSTABLE.

LOWER FOOT VALVE UNTIL IT REACHES A DEPTH OF 10 TO 20 FEET BELOW THE LOWEST ANTICIPATED WATER LEVEL (DRAW DOWN LEVEL). TO PREVENT SAND AND SEDIMENT FROM ENTERING PUMPING SYSTEM, MAKE SURE THAT THE FOOT VALVE IS AT LEAST 5 FEET ABOVE BOTTOM OF WELL.

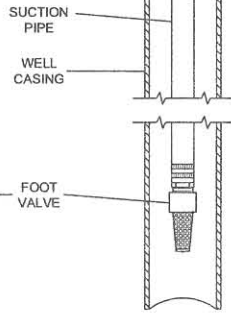

**FIGURE 2A-
CONVERTIBLE JET PUMP (SINGLE STAGE)
SHALLOW WELL SYSTEM**

25 FEET OR LESS TOTAL SUCTION LIFT =
PUMP TO WATER DEPTH + SUCTION PIPE FRICTION LOSS

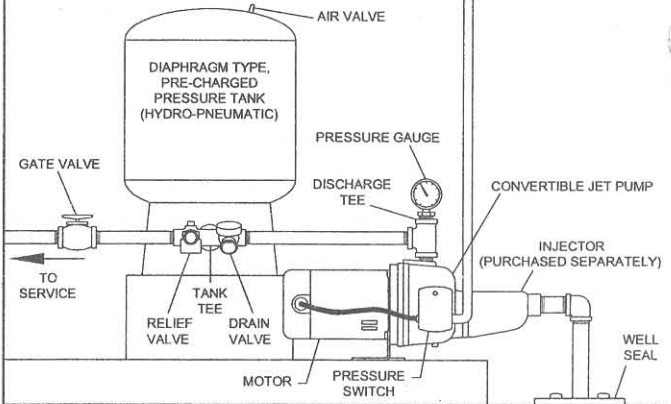

NOTE: DURING INSTALLATION, WHILE THE PRE-CHARGED TANK IS EMPTY, CHECK THE PRE-CHARGE AIR PRESSURE WITH A TIRE PRESSURE GAUGE. THE TANK PRE-CHARGE SHOULD BE ADJUSTED TO 2 PSI LOWER THAN THE PUMP CUT-IN (TURN ON) PRESSURE SWITCH SETTING. LANCASTER PUMP JET PUMPS ARE SUPPLIED WITH PRESSURE SWITCHES FACTORY PRE-SET TO 20-40 (CUT IN-CUT OUT) PSI. PRESSURE SWITCHES ARE FIELD ADJUSTABLE.

LOWER FOOT VALVE UNTIL IT REACHES A DEPTH OF 10 TO 20 FEET BELOW THE LOWEST ANTICIPATED WATER LEVEL (DRAW DOWN LEVEL). TO PREVENT SAND AND SEDIMENT FROM ENTERING PUMPING SYSTEM, MAKE SURE THAT THE FOOT VALVE IS AT LEAST 5 FEET ABOVE BOTTOM OF WELL.

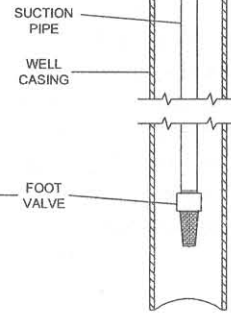

**FIGURE 2B-
CONVERTIBLE JET PUMP (SINGLE STAGE)
OR DEEP WELL JET PUMP (DUAL STAGE)
TWIN PIPE DEEP WELL SYSTEM**

25 FEET OR MORE TOTAL SUCTION LIFT =
PUMP TO WATER DEPTH + SUCTION PIPE FRICTION LOSS

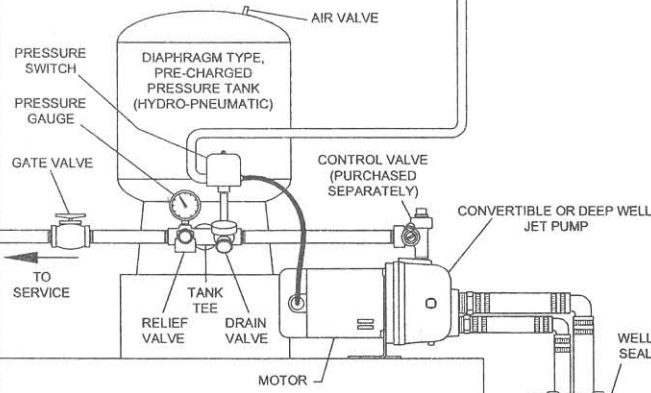

NOTE: DURING INSTALLATION, WHILE THE PRE-CHARGED TANK IS EMPTY, CHECK THE PRE-CHARGE AIR PRESSURE WITH A TIRE PRESSURE GAUGE. THE TANK PRE-CHARGE SHOULD BE ADJUSTED TO 2 PSI LOWER THAN THE PUMP CUT-IN (TURN ON) PRESSURE SWITCH SETTING. LANCASTER PUMP JET PUMPS ARE SUPPLIED WITH PRESSURE SWITCHES FACTORY PRE-SET TO 20-40 (CUT IN-CUT OUT) PSI. PRESSURE SWITCHES ARE FIELD ADJUSTABLE.

LOWER INJECTOR ASSEMBLY UNTIL IT REACHES A DEPTH OF 10 TO 20 FEET BELOW THE LOWEST ANTICIPATED WATER LEVEL (DRAW DOWN LEVEL). TO PREVENT SAND AND SEDIMENT FROM ENTERING PUMPING SYSTEM, MAKE SURE THAT THE FOOT VALVE IS AT LEAST 5 FEET ABOVE BOTTOM OF WELL.

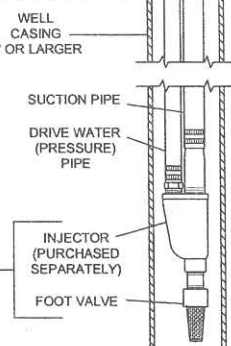

**FIGURE 3-
CONVERTIBLE JET PUMP (SINGLE STAGE)
OR DEEP WELL JET PUMP (DUAL STAGE)
PACKER DEEP WELL SYSTEM**

25 FEET OR MORE TOTAL SUCTION LIFT =
PUMP TO WATER DEPTH + SUCTION PIPE FRICTION LOSS

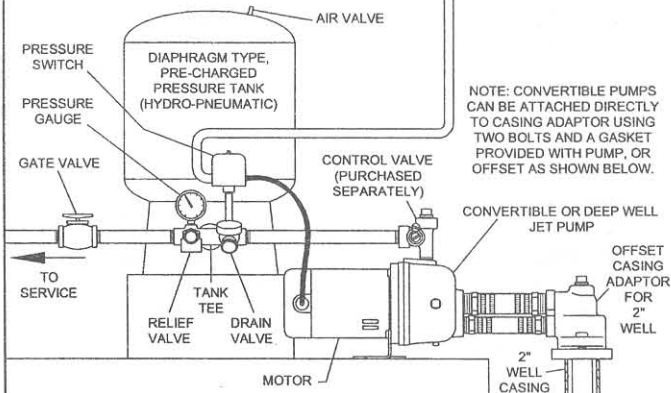

NOTE: DURING INSTALLATION, WHILE THE PRE-CHARGED TANK IS EMPTY, CHECK THE PRE-CHARGE AIR PRESSURE WITH A TIRE PRESSURE GAUGE. THE TANK PRE-CHARGE SHOULD BE ADJUSTED TO 2 PSI LOWER THAN THE PUMP CUT-IN (TURN ON) PRESSURE SWITCH SETTING. LANCASTER PUMP JET PUMPS ARE SUPPLIED WITH PRESSURE SWITCHES FACTORY PRE-SET TO 20-40 (CUT IN-CUT OUT) PSI. PRESSURE SWITCHES ARE FIELD ADJUSTABLE.

LOWER PACKER ASSEMBLY UNTIL IT REACHES A DEPTH OF 10 TO 20 FEET BELOW THE LOWEST ANTICIPATED WATER LEVEL (DRAW DOWN LEVEL). TO PREVENT SAND AND SEDIMENT FROM ENTERING PUMPING SYSTEM, MAKE SURE THAT THE FOOT VALVE IS AT LEAST 5 FEET ABOVE BOTTOM OF WELL.

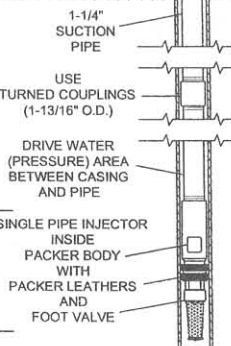

NOTE: CONVERTIBLE PUMPS CAN BE ATTACHED DIRECTLY TO CASING ADAPTOR USING TWO BOLTS AND A GASKET PROVIDED WITH PUMP, OR OFFSET AS SHOWN BELOW.

FIGURE 4A-
DUG OR BORED WELL
(SHALLOW WELL)

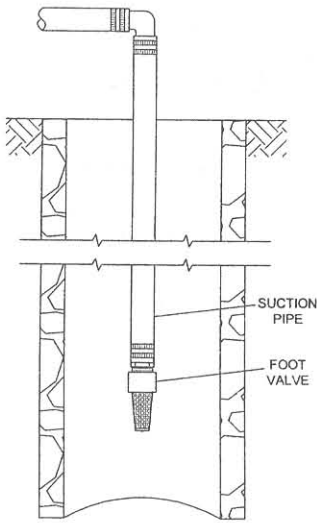

FIGURE 4B-
CISTERN
(SHALLOW WELL)

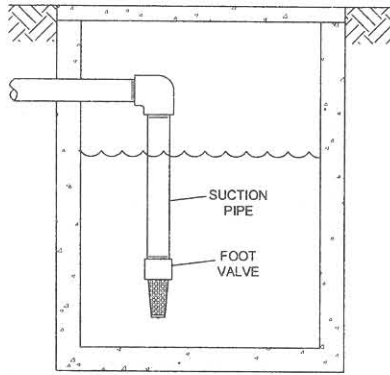

FIGURE 5A-
1-1/4" DRIVEN WELL
(SHALLOW WELL)

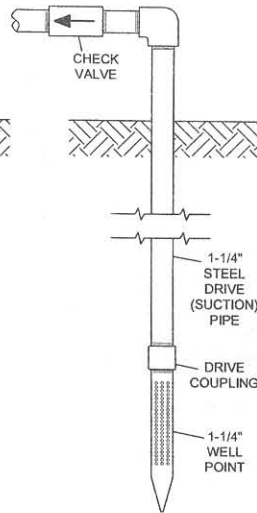

FIGURE 5B-
2" DRIVEN WELL
(DEEP WELL)

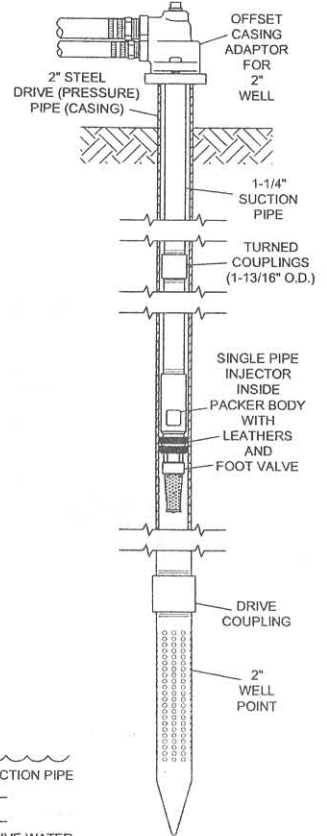

FIGURE 6A-
LAKE, RIVER OR SPRING
(SHALLOW WELL)

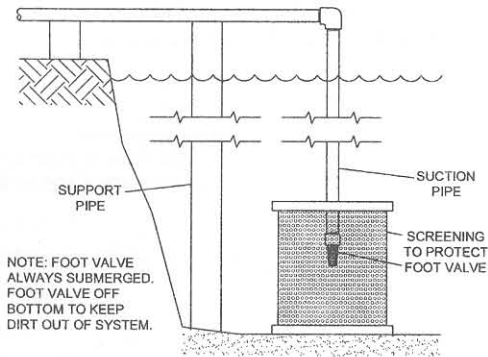

FIGURE 6B-
LAKE, RIVER OR SPRING
(DEEP WELL)

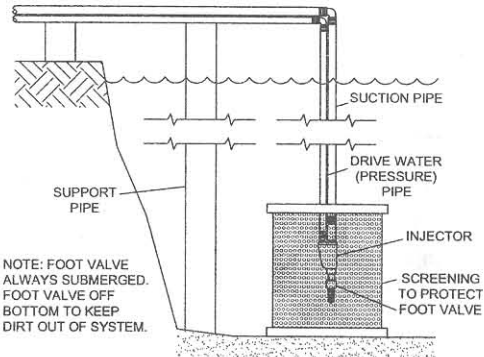
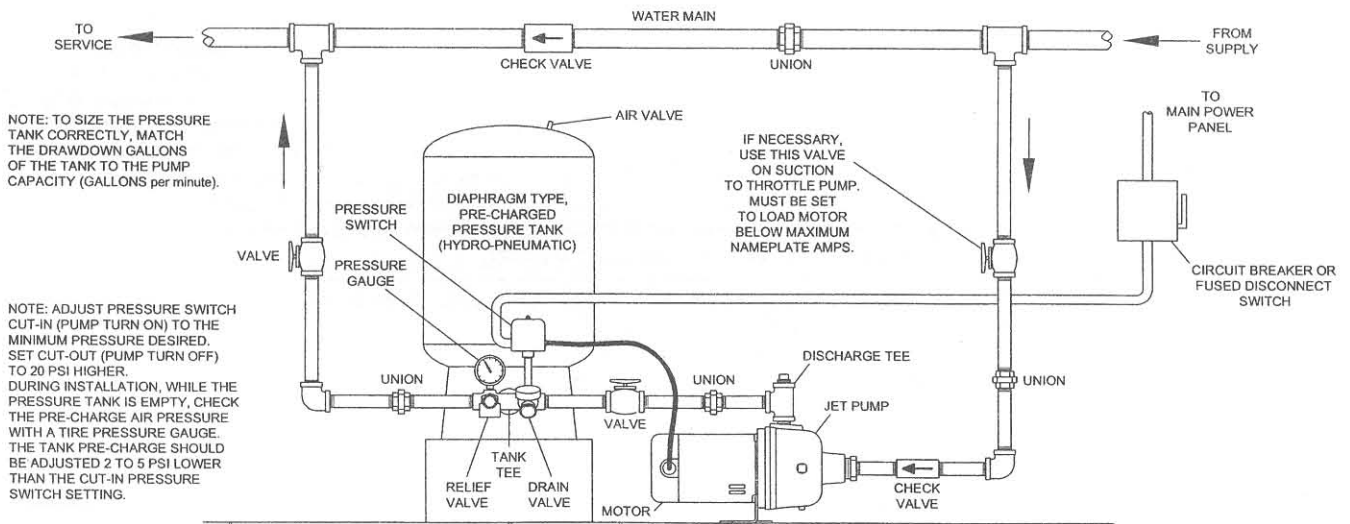

FIGURE 7-
SHALLOW WELL OR CONVERTIBLE (WITH INJECTOR BOLTED ON) JET PUMP
CITY WATER PRESSURE BOOSTER SYSTEM



TROUBLESHOOTING

PROBLEM	POSSIBLE CAUSE(S) / SOLUTION
MOTOR WILL NOT RUN	<ol style="list-style-type: none"> 1. Disconnect switch is off. Be sure switch is on. 2. Blown fuse or tripped open circuit breaker. Replace with properly sized fuses or reset circuit breaker. Call dealer or electrician for recommended size. 3. Defective pressure switch. Pressure switch contacts may be dirty. DISCONNECT POWER and replace switch or file contacts with emery board or nail file. 4. Reset low pressure cutoff switch (if installed). 5. Defective wiring. DISCONNECT POWER; check for loose or corroded connection or incorrect wiring. 6. Impeller binding. Call dealer for repair or replacement.
MOTOR RUNS HOT AND OVERLOAD KICKS OFF	<ol style="list-style-type: none"> 1. Make sure motor is set up for correct voltage. Refer to "Pre-Installation Preparation" section of this manual, and review the "Electrical Connections" data. 2. Voltage is too low. Wire size too small. Call dealer or electrician. The supply voltage must be $\pm 10\%$ of the motor rated voltage. Contact power company if supply voltage is low. 3. Motor does not get necessary ventilation. Provide ventilation or move away from heat source. 4. Pump starts and stops (cycles) too frequently. See next section "Pump starts too frequently".
PUMP STARTS TOO FREQUENTLY	<ol style="list-style-type: none"> 1. Pre-charged tank water-logged (loss of air pressure). Adjust air pressure to 2 PSI less than cut-in pressure (when there is no water pressure on system). Check tank for leaks. Must be air and water tight. Replace if necessary. Is tank sized too small to meet system demand? Call dealer. 2. Galvanized steel tank is water logged and has no air cushion. Drain tank to air volume control port. Check AVC for defects. Check tank for leaks. Replace if necessary. 3. Defective pressure switch or switch out of adjustment. Readjust or replace pressure switch. Pressure switch and pump should be located as close to tank as possible. 4. Pipes leak. Check connections. 5. Faucet open. Close faucet. 6. Foot valve leaks. If stuck open, water will leak back. Replace foot valve.
AIR SPURTS FROM FAUCETS	<ol style="list-style-type: none"> 1. Pump is picking up prime. When pump picks up prime, all air will be ejected. 2. Intermittent over-pumping of well (water drawn down below foot valve). Lower foot valve is possible, otherwise reduce pump discharge flow. 3. Suction pipe is sucking air. Check joints. 4. Well is gaseous. Consult factory.
MOTOR RUNS BUT PUMP DELIVERS LITTLE OR NO WATER	<ol style="list-style-type: none"> 1. Pump is not properly primed. If pump is offset, check horizontal suction for dips or high spots. Pipe must have a gradual slope from pump downward to well. Re-prime according to instructions in the "Operation" section of this manual. 2. Air leaks - check all connections on suction line. 3. Foot valve may be leaking, clogged or corroded shut. Injector may be clogged. Remove and clean or replace. 4. Foot valve may be buried in mud or sand - raise foot valve above well bottom. 5. Pipes are frozen. Thaw pipes. Bury pipes below frost line. Heat pit or pump house. 6. Steel piping (if used) is corroded or limed, causing excessive friction. Replace with plastic pipe where possible, otherwise with new steel pipe. 7. Pipe is too small in size. Use larger pipe. 8. For deep well pumps, the control valve may be closed too much causing operating pressure to be too high. Set the control valve to minimum pressure capable of maintaining prime within pump. Review priming instruction in the "Operation" section of this manual. 9. System head too high. 10. Low voltage causing reduced motor speed. 11. Check vertical distance to water. If over 25', a shallow well pump will not deliver and a deep well pump is needed. On a shallow well installation, a vacuum gauge installed on the suction line as close to the pump as possible will inform you how far the water is from the pump. Each inch (1") of mercury (Hg.) on the vacuum gauge = 1.13' of total suction lift (vertical lift + friction loss) at sea level. For every 1000' above sea level, deduct 1' from the total suction lift. While the pump is operating, if the vacuum gauge reads 22" Hg. or more (25' lift or more), the suction pipe is buried in mud, or the foot valve or check valve is stuck closed, or the suction lift exceeds lift capacity of pump. While the pump is operating, if the vacuum gauge is rapidly fluctuating or zero vacuum is indicated, the suction pipe is not submerged or there is an air leak (the well may be producing less than pump capacity).
PUMP DELIVERS WATER BUT DOES NOT SHUT OFF	<ol style="list-style-type: none"> 1. Pressure switch is plugged, cut-out setting is too high or contacts are welded. DISCONNECT POWER; clean contacts, adjust setting or replace switch. 2. Faucets have been left open. Close faucets. Check for leaks. 3. Injector (nozzle and venturi) or impeller partially clogged. Clean injector or impeller. 4. Low voltage causing reduced motor speed. 5. System head too high. 6. Suction lift or suction losses excessive. Review item #11 in above section "Motor Runs But Pump Delivers Little or No Water".